

**Compact NSX400-630  
FPower NSX / GV7**

Circuit breaker/Switch-disconnector  
Disjoncteur/Interrupteur-sectionneur  
Interruptor automático/Interruptor seccionado

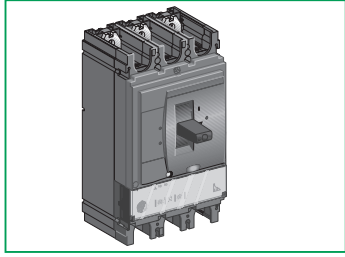

Merlin Gerin  
Square D  
Telemecanique

**Schneider Electric**

GHD16243AA-03

**Schneider Electric Industries SAS**  
89, boulevard Franklin Roosevelt  
F-92505 Rueil-Malmaison Cedex (France)  
Tel: + 33 (0)1 41 29 85 00  
www.schneider-electric.com



© 2007 Schneider Electric.  
All rights reserved.

**IMPORTANT NOTE**

- This device must be installed by a qualified electrician.
- We cannot accept any responsibility for failure to follow the instructions provided in this document.
- Read and understand the safety instructions accompanying this document before performing any procedure

**REMARQUE IMPORTANTE**

- L'installation de cet appareil doit être effectuée par des professionnels de l'électricité.
- Le non-respect des indications de la présente notice ne saurait engager la responsabilité du constructeur.
- Lisez attentivement les consignes de sécurité jointes à ce document avant toute opération.

**OBSERVACIÓN IMPORTANTE**

- La instalación y mantenimiento de este aparato sólo debe ser realizado por electricistas profesionales.
- El fabricante no se hace responsable en caso de no cumplir con las indicaciones expuestas en este aviso.
- Lea atentamente las indicaciones de seguridad adjuntas a este documento antes de realizar cualquier operación.

**重要注意事項**

- 本装置必须由合格的电工进行安装。
- 我们不承担任何因未遵循本文档中的指南而导致的责任。
- 请在执行任何操作之前阅读并理解本文档中的安全指南。

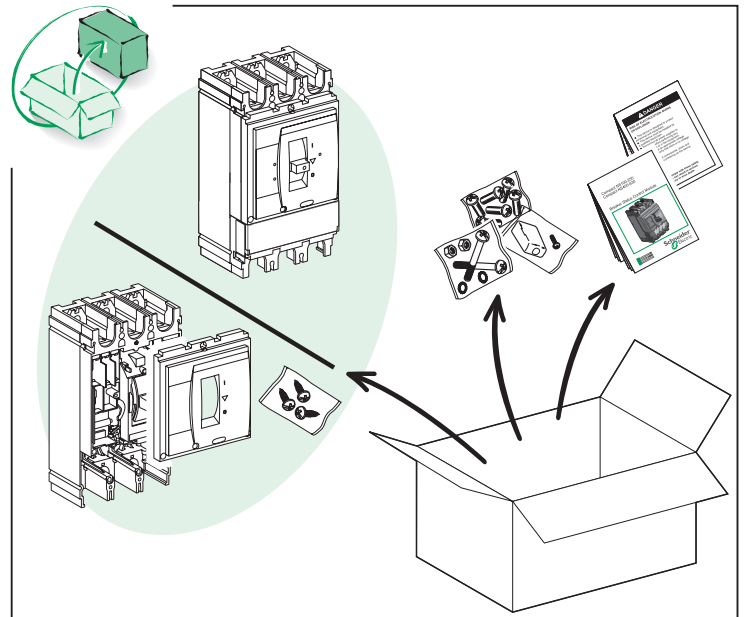

**NSX400-630**

3P 6 (M10 x 27,5)		3P-4P 2 Ø4 x 20	
4P 8 (M10 x 27,5)		3P-4P 1 Ø4 x 14	
3P 4 (M5 x 85)		3P-4P 1 Ø5 x 16	
4P 4 (M5 x 85)		4P 1 Ø3 x 10	

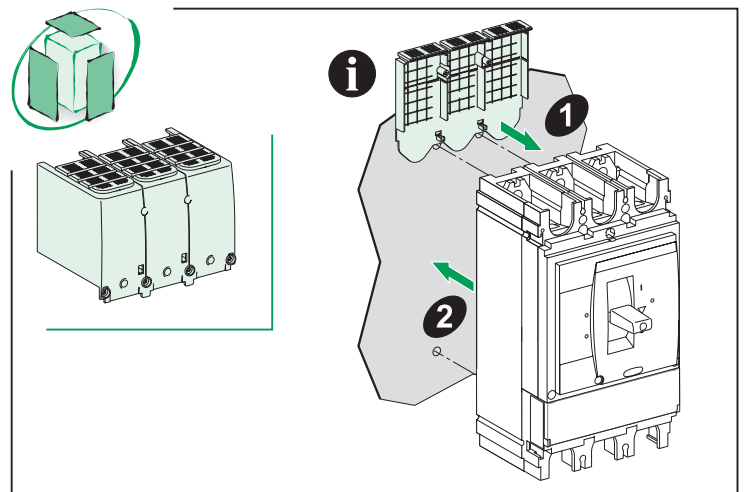
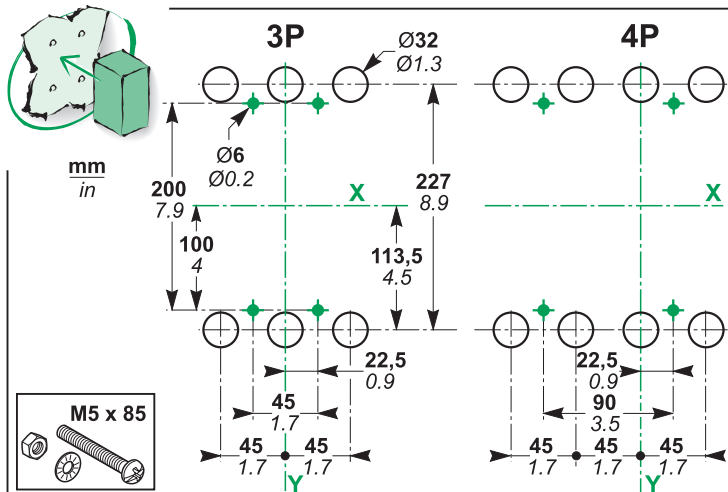
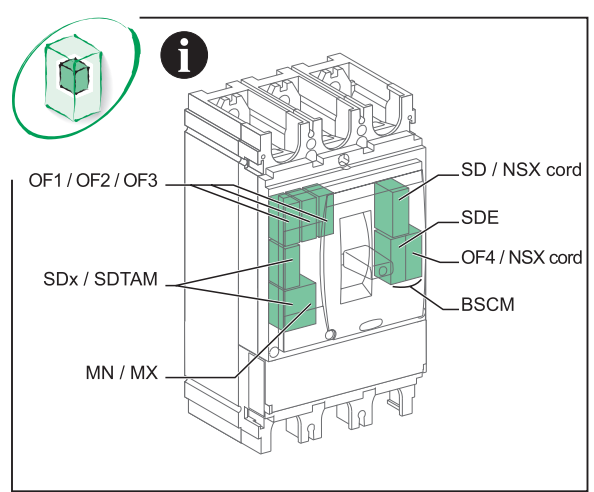
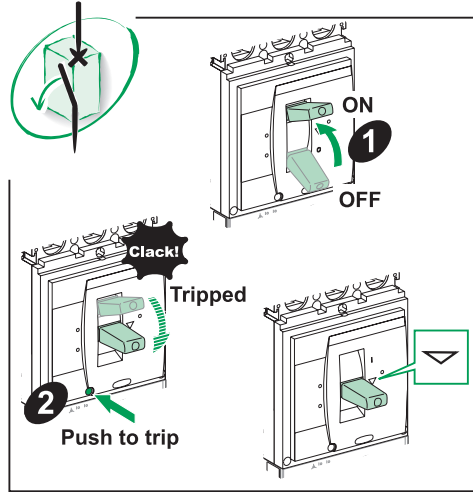
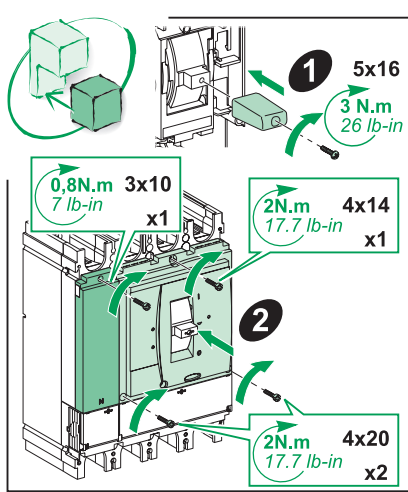
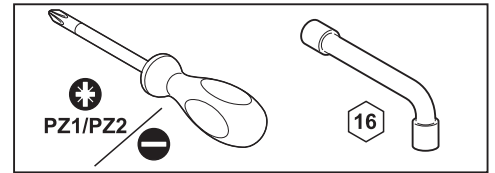

GHD16243AA-03

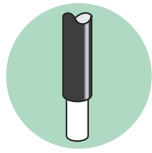
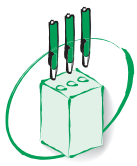

mm  
in

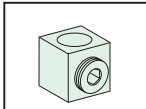

3P LV432479  
4P LV432480

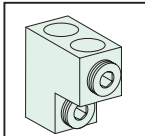

3P LV432481  
4P LV432482

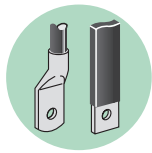
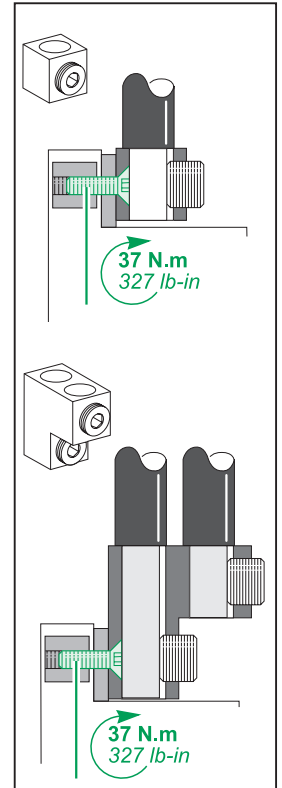
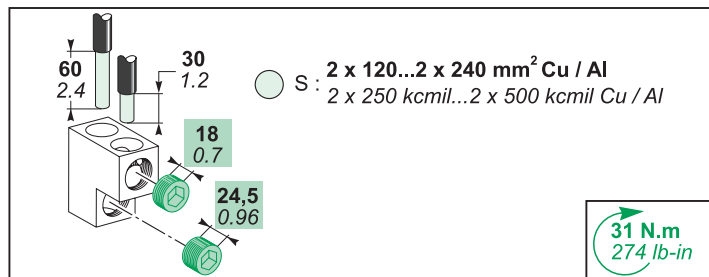
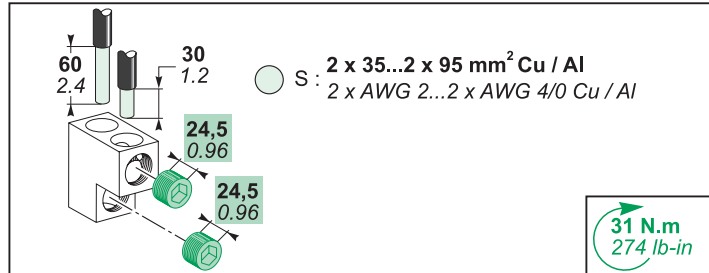
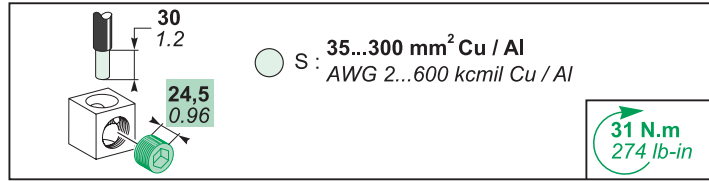
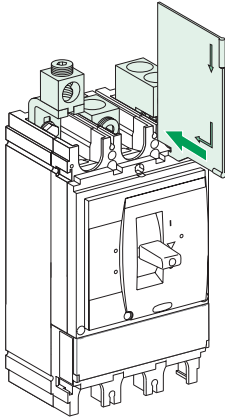

mm  
in

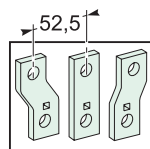
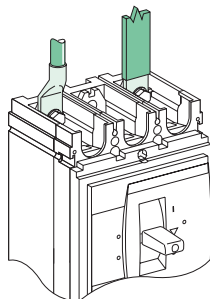
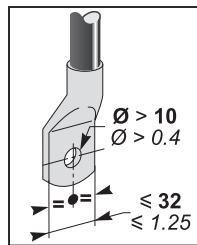
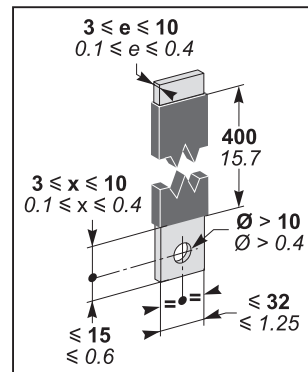

3P LV432490  
4P LV432491

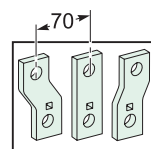

3P LV432492  
4P LV432493

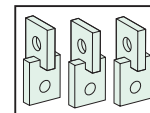

3P LV432486  
4P LV432487

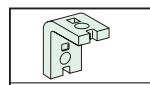
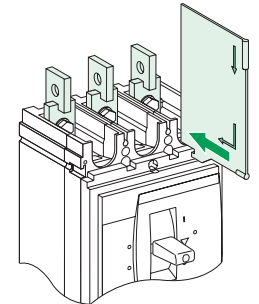
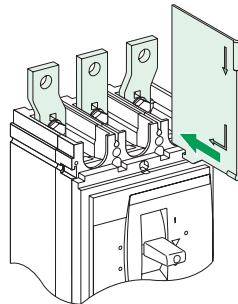

3P LV432484  
4P LV432485

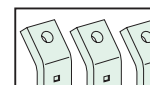
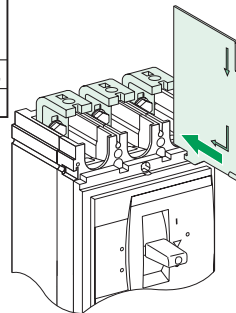

3P LV432586  
4P LV432587

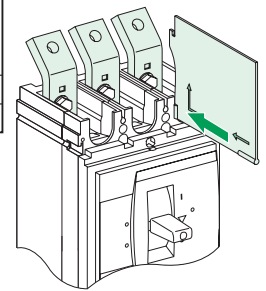

M10 x 27,5



50 N.m  
442 lb-in

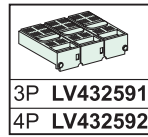
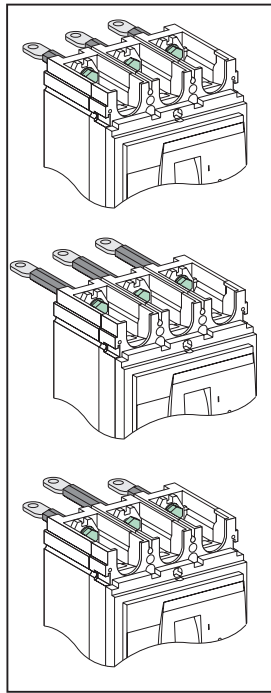
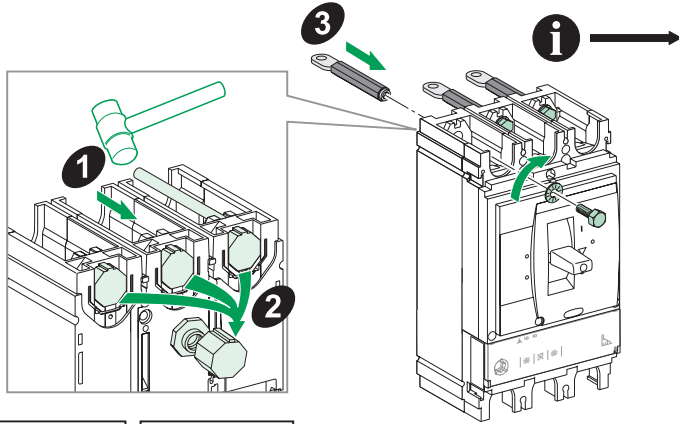
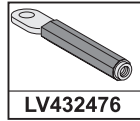
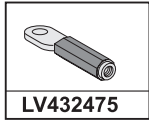
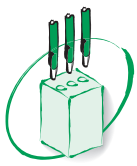

**Mandatory U ≥ 500 V**  
**Obligatoire U ≥ 500 V**  
**Obligatorio U ≥ 500 V**

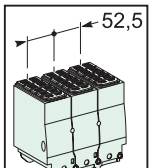
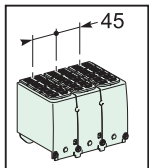
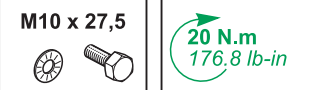
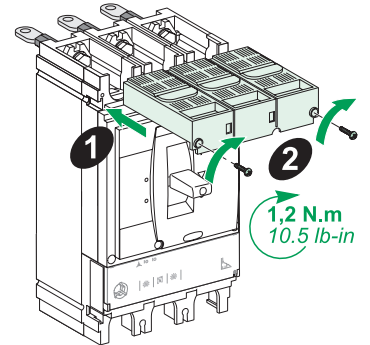

**Mandatory U ≥ 500 V**  
**Obligatoire U ≥ 500 V**  
**Obligatorio U ≥ 500 V**

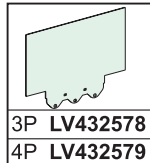
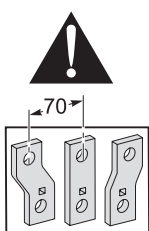
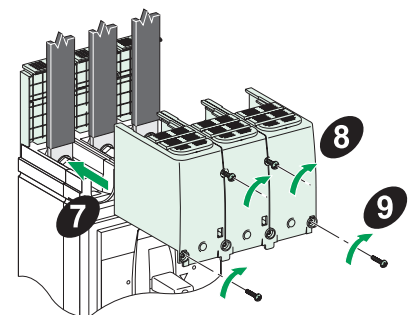
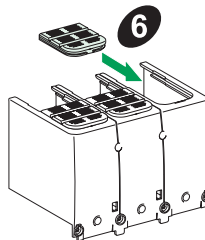
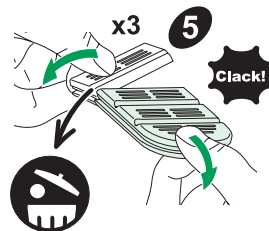
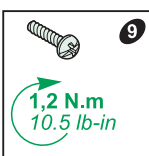
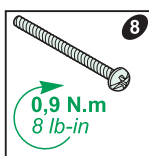
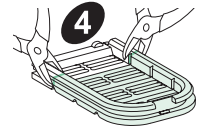
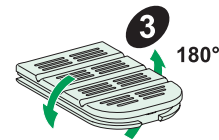
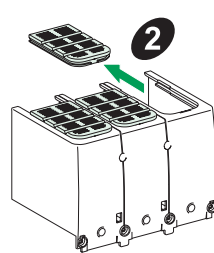
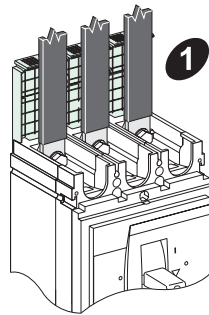

**Mandatory U ≥ 500 V**  
**Obligatoire U ≥ 500 V**  
**Obligatorio U ≥ 500 V**

